

Installation Guide

10GX Shielded KeyConnect Modular Jack

PX105477 Release A



Page 1 of 2

1. Cable Preparation

1.1 Cut off approx. a 2 in. (5 cm) portion of the jacket.

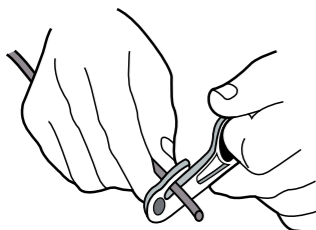

Cable Preparation Tool (1797B)

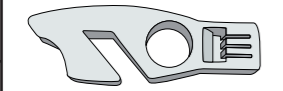

1.2

- Slit jacket approx. 4 in. (10 cm) with ripcord, or use a standard slitting tool;
- Cut off jacket at the bottom of slit.

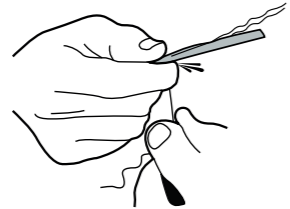

1.3

- Bend the drain wire down along the jacket;
- Cut the Ripcord;
- Cut the Binder.

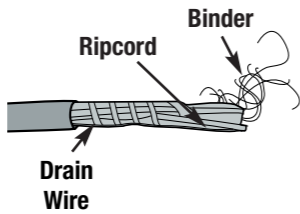

1.4

- Keep 0.5 in. (1 cm) of the aluminium-polyester screen;
- Wind the drain wire around the aluminium foil.

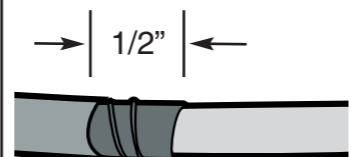

1.5 Remove the internal jacket up to the aluminum - polyester tape.

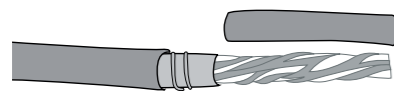

1.6 Cut off cross-web.

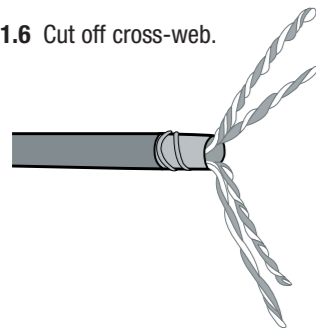

2. Wire Guide Preparation

2.1 A For **TIA568-A** configuration, align pairs as shown;

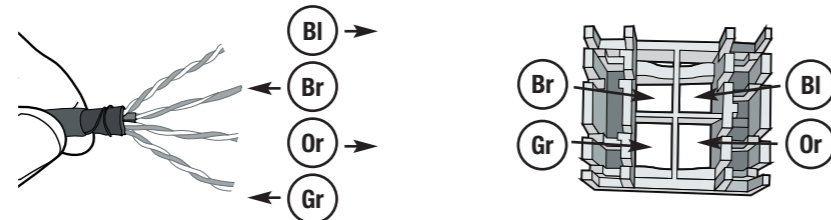

Tips: Depending of the cable end, no crossing is required or cross both combination (Bl-Br) and (Or-Gr).

2.1 B For **TIA568-B** configuration, align pairs as shown;

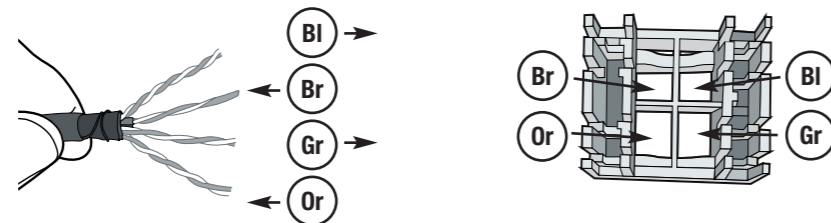

Tips: Depending of the cable end, cross (Bl-Br) pairs or (Or-Gr) pairs.

2.2

- Push the Wire Guide against the internal Jacket;
- Untwist the wire pairs;
- Split the bonded pairs.

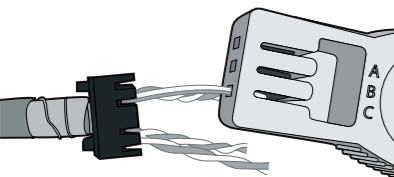

Tips: Use the "C" opening of the Cable Preparation Tool (1797B)

2.3 Lay the wires in their correct position based on the Wire Guide color code.

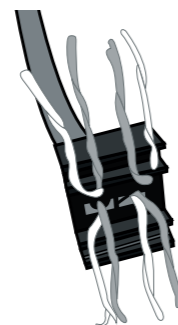

2.4 Cut the extra wires with a flush cutter. The tips of the wires should protrude no more than 1/16 in (0.5mm).

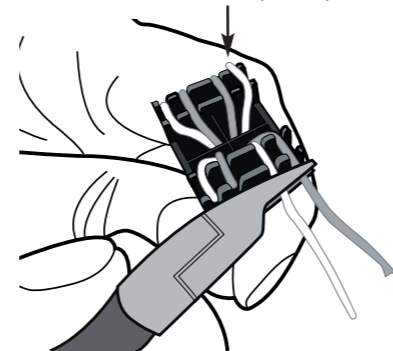

3. Module Termination

3.1

- Align the Wire Guide's arrows with the Module arrows;
- Press the Wire Guide on the IDC tower.

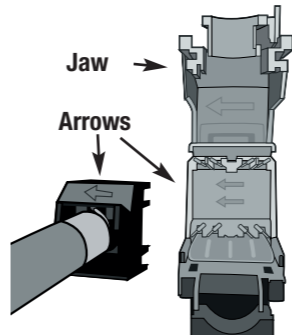

3.2

- Close the jaw until it clicks into place;
- Slide the shielding lug close to the jacket.

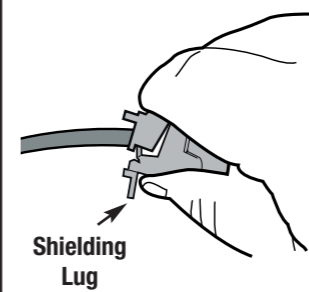

3.3 Caution: Make sure that drain wire is wrapped under the shielding lug;

- Wrap the cable tie around the shielding lug and position it as shown.

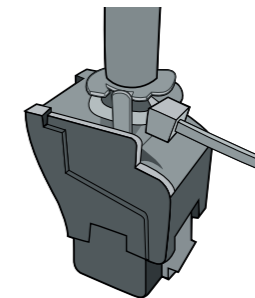

3.4 Before cutting the extra length, make sure that the cable tie is tightened.

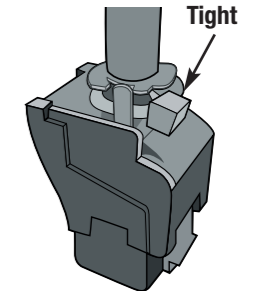

4. Module Installation in Patch Panel

4.1

- To insert, engage the bottom of the module in the opening;
- Then press the top latch and pivot the Module as shown.

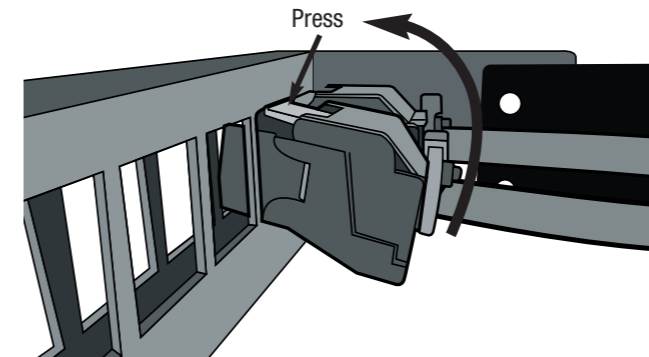

4.2 Refer to the Shielded KeyConnect Patch Panel Installation Guide (PX105408). Always respect the minimum cable bend radius.

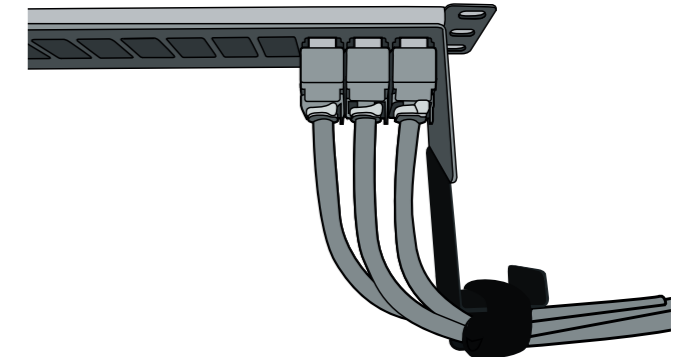

5. Module Removal Instructions

5.1

- Press down with a flat screw driver on the top latch, once free, press down on the module;
- Pivot the Module and lift it.

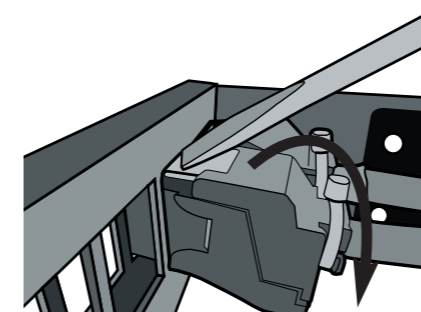

5.2 Cut off the cable tie.

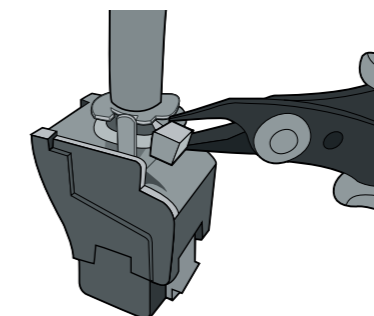

5.3

- Pull out the shielding lug completely;
- Insert the screwdriver into the slot and rotate it to open the jaw.

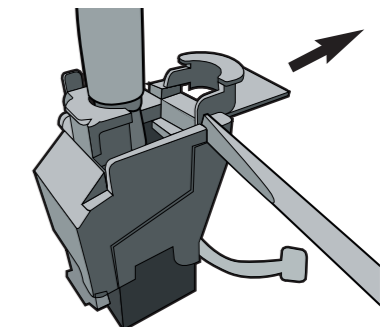

This Installation Guide is available in the "Document Center" of the Belden Networking website - www.belden.com

© 1996, 2011 Belden, Inc.
Printed in Canada