

Installation Guide

FiberExpress* 1U/2U Rack Mount Distribution Panel Accessories

Version 04.00 2007

PX100104

Legend



Repeat



Direction of action



Step

Right Cable Entry Bracket

To install the right cable entry bracket:

Fasten the right cable entry bracket to the strain relief bracket as shown.

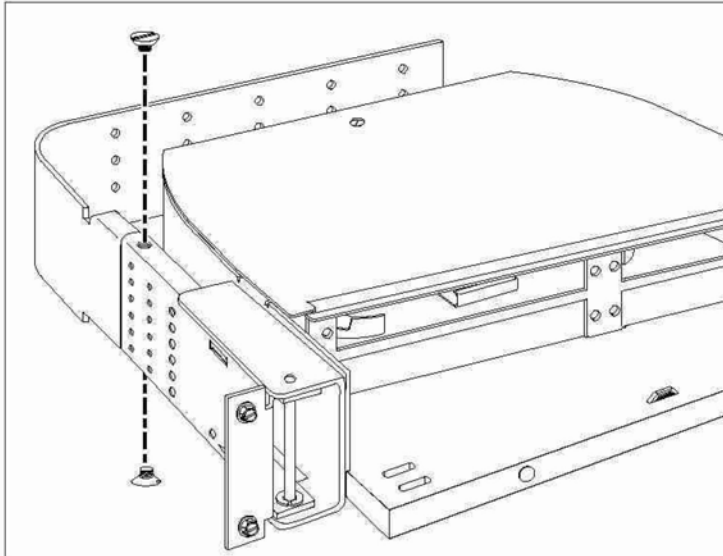

Front Cover

A

To close the front of the patch panel:

- 1 Remove the hole plugs from the patch panel.
- 2 Pull the buttons to unlock the Nylatch fasteners.
- 3 Insert the front cover in the top cover and align the Nylatch fasteners with holes.
- 4 Push the buttons to secure the front cover to the patch panel.
- 5 Place administration and FPPA labels as shown. Make sure FPPA Number is same as on the patch panel.

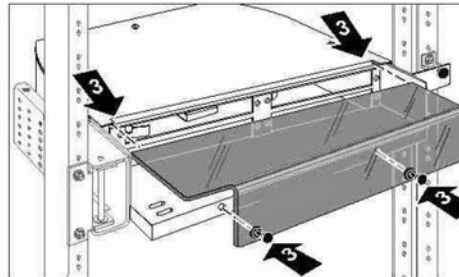
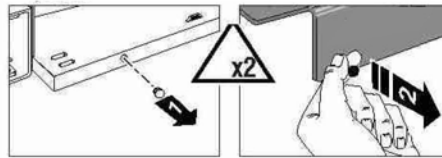

B

To open the front of the patch panel:

- 1 Pull the buttons to unlock the Nylatch fasteners.
- 2 Remove the front cover.

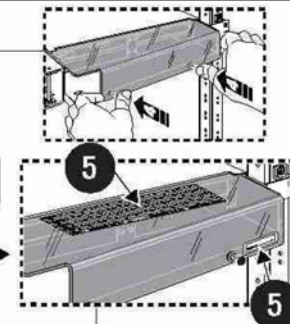
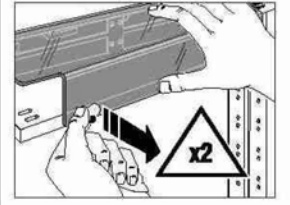

12.7cm (5 in.) Offset Installation

To do the offset installation:

- 1 Secure the offset installation bracket to the strain relief bracket.
- 2 Secure the appropriate universal receptacle to the rack.
- 3 Secure the patch panel to the rack. **MAKE SURE THAT THE THUMBSCREW IS PERFECTLY ALIGNED WITH THE HOLE OF THE UNIVERSAL RECEPTACLE !**

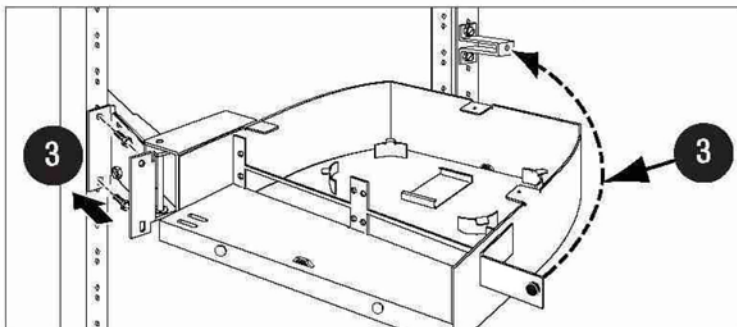
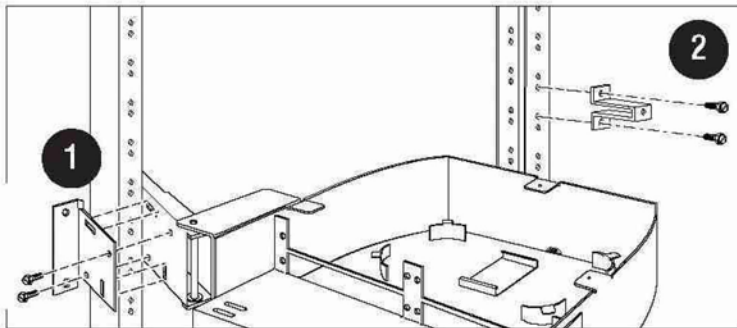

Connector Strip

A

To install the strip:

- 1 Pull the buttons to unlock the Nylatch fasteners.
- 2 Insert the strip onto panel mount.
- 3 Push the buttons to secure the strip to the panel mount.

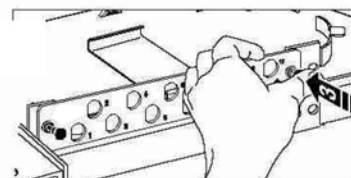
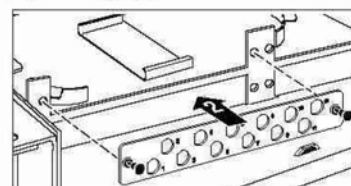
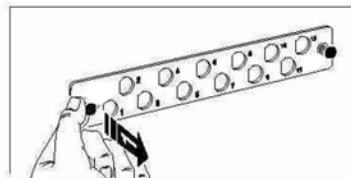

B

To remove the strip:

- 1 Pull the buttons to unlock the Nylatch fasteners.
- 2 Remove the strip.

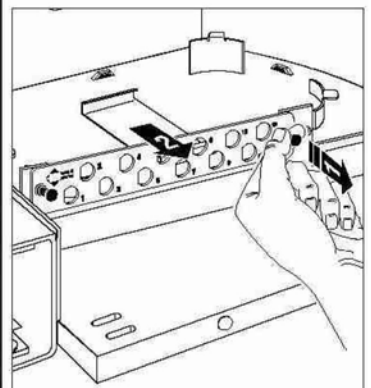

BELDEN

*FiberExpress is a trademark of Belden .
All other trademarks are the properties of their respective owners.